



# Stairs & Mezzanines

Aluminum Profile System

CUSTOM ENGINEERED SOLUTIONS

Industry Standard T-Slot Profile - Extensive Range of Parts & Components - Sales & Engineering Support

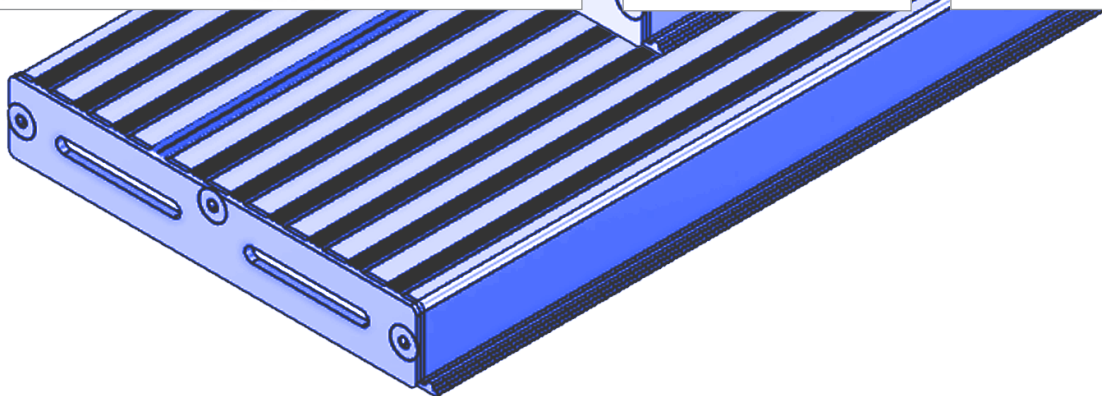
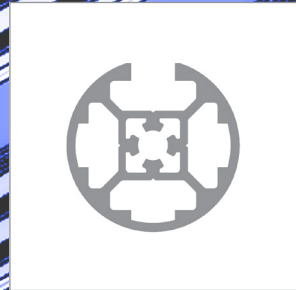
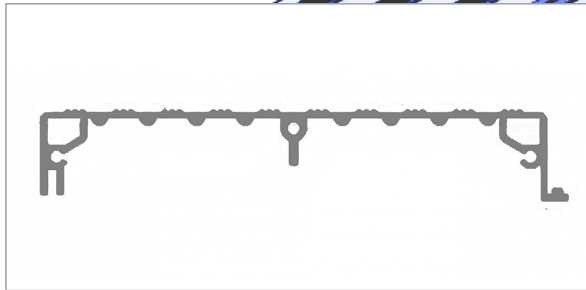



## Aluminum Alloy Stairs vs. Steel Stairs

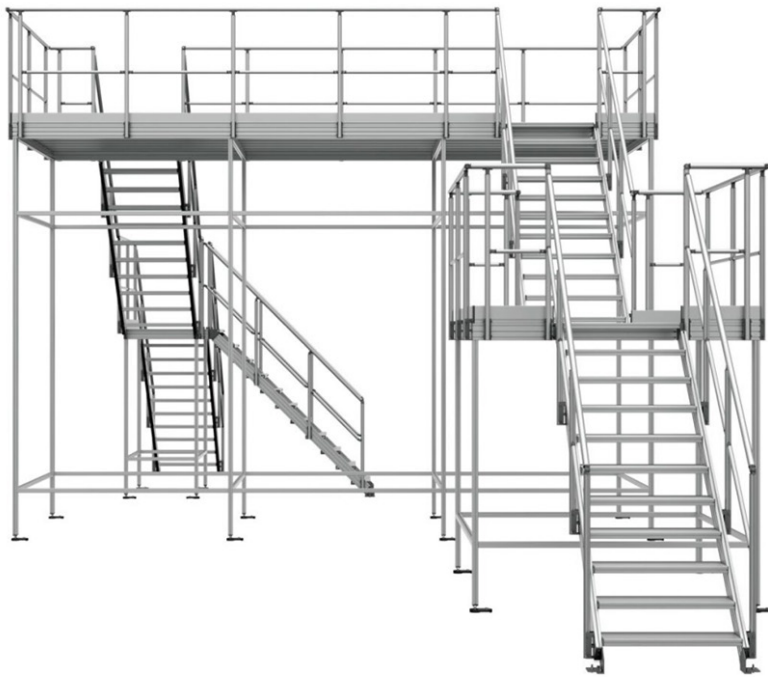

- **Flexible Assembly**
  - Quick to customize
  - Fast production cycle
- **No Surface Treatment/Less Maintenance Required On Site**
  - Ongoing painting and preventative maintenance not required.
  - Material doesn't rust or degrade over time, even with water present.
- **Structure Can Be Adjusted After Manufacturing With Just a Few Tools.**
  - Our stair system primarily uses T-slot profile and innovative hardware which greatly reduces the amount of milling, drilling and tapping required. This also makes adjustments and many alterations much quicker and easier than other stair systems.
- **Aesthetically Pleasing**
  - Our stair system consists of a variety of sturdy but sleek aluminum profiles in various shapes, sizes and contours. These profiles are state of the art designs which deliver industrial grade strength without the industrial grade appearance.
  - In addition we offer a number of panel insert options to further customize your application.
- **Lighter Weight**
  - Easier to manipulate for construction and/or movement.

## Experienced Engineers

Skilled engineers on staff are able to offer custom solutions in a wide variety of applications including structures, platforms and barriers. Their experience and product knowledge help to access what is needed to create a safe and functional solution for your needs.



## Knowledgeable Sales Staff













Our knowledgeable sales staff can review your application to offer the best products available. If you are experiencing supply chain issues, looking to reduce your costs, looking for a complete custom solution or an automation package, contact us to see how we can help.

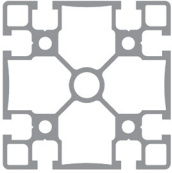

## Dedicated Customer Service

At Modular Solutions we strive to provide our customers with unparalleled service to help them through every stage of their project, no matter how big or small. Our friendly and dedicated customer service reps are more than happy to assist you at any time.

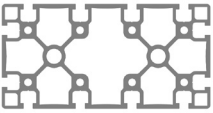

			
<p><b>10-940-1</b> Step Profile</p>	<p><b>10-40R1-0</b> Round Profile 40MM 1 Slot</p>	<p><b>10-40R2-0</b> Round Profile 40MM 2 Slot</p>	<p><b>10-4545-0</b> Square Profile 45MM X 45MM UL</p>
			
<p><b>10-4545H-0</b> Square Profile 45MM X 45MM Heavy</p>	<p><b>10-4590-0</b> Square Profile 45MM X 90MM UL</p>	<p><b>10-4590H-0</b> Square Profile 45MM X 90MM Heavy</p>	<p><b>10-9090-0</b> Square Profile 90MM X 90MM S</p>
			
<p><b>10-9090H-0</b> Square Profile 90MM X 90MM Heavy</p>	<p><b>10-45180-0</b> Square Profile 180MM X 45MM</p>	<p><b>10-18090-0</b> Square Profile 180MM X 90MM</p>	<p><b>10-18032-0</b> Square Profile 180MM X 32MM</p>



Did you know most of our T-slot aluminum profile is made in the U.S.A.? This cuts down on additional time & costs from overseas shipments and allows us to offer our customers a quality product at a lower cost.



General		
	Material: EN-AW-6063 T66 Aluminum Alloy	Material: EN-AW-6060 T5/T6 Aluminum Alloy
	Specific Weight: 2.75 g / cm <sup>3</sup>	Specific Weight: 2.70 g / cm <sup>3</sup>
	Modulus of Elasticity: E: 70000 N / mm <sup>2</sup>	Modulus of Elasticity: E: 68000 N / mm <sup>2</sup>
	Shear Modulus: G: 27000 N/mm <sup>2</sup>	Shear Modulus: G: 26000 N/mm <sup>2</sup>
	Expansion Hardness: ca. 75 HB 2.5 / 187.5	Expansion Hardness: ca. 70 HB 2.5 / 187.5
	Layer Thickness: ca. 10 um	Layer Thickness: ca. 10 um

Chemical Composition										
Alloy	Al	Si	Fe	Cu	Mn	Mg	Cr	Zn	Ti	Others
6063 T66	Balance	0.20-0.6	- 0.35	max 0.10	max 0.10	0.45-0.9	max 0.10	max 0.10	max 0.10	0.05-0.15
6060 T5/T6	Balance	0.3-0.6	0.1-0.3	max 0.10	max 0.10	0.35-0.6	max 0.05	max 0.15	max 0.10	0.05-0.15

Mechanical Properties					
Alloy	Fatigue Endurance Limit [MPa]	Yield Strength [MPa]	Tensile Strength [MPa]	Sheer Strength [MPa]	Hardness HB
6063 T6	68.9	214	241	73	73
6060 T5/T6	70	190	220	70	70

Other
The following are suitability from 1 (Excellent) to 6 (Not Advisable)
Weldability - Gas: 3 TIG: 2 MIG: 2
Machining Temper Characteristic: 2
Coating Properties - Hard Protecting Anodizing: 1 Decorative Bright Colour Anodizing: 2
Corrosion Resistance - General: 1 Marine: 2

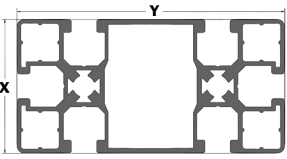
Profile Technical Data									
	Alloy	Part Number	X (mm)	Y (mm)	Weight (Kg/m)	I <sub>x</sub> (cm <sup>4</sup> )	I <sub>y</sub> (cm <sup>4</sup> )	W <sub>x</sub> (cm <sup>4</sup> )	W <sub>y</sub> (cm <sup>4</sup> )
	6060 T6	10-940-1	45	270	4.01	22.89	1239.82	10.06	91.16
	6063 T6	10-40R1-0	40	40	1.35	5.7	6.5	2.85	3.25
	6063 T6	1040R2-0	40	40	1.30	5	6.5	2.5	3.25
	6063 T6	10-4545-0	45	45	1.46	9.69	9.69	4.31	4.31
	6063 T6	10-4545H-0	45	45	1.81	12.39	12.39	5.51	5.51
	6063 T6	10-4590-0	45	90	2.42	18.87	74.17	8.39	16.48
	6060 T6	10-4590H-0	45	90	3.36	25.25	98.82	11.22	21.96
	6063 T6	10-9090-0	90	90	3.78	131.72	131.72	29.27	29.27
	6060 T6	10-9090H-0	90	90	5.62	170.58	170.58	37.9	37.9
	6060 T6	10-45180-0	45	180	5.96	48.33	689.89	21.48	76.65
	6060 T6	10-18018.5-0	180	18.5	4.65	401.00	6.65	44.5	7.18
	6060 T6	10-18032-0	180	32	6.11	606.86	25.01	67.43	15.63
	6060 T6	10-18090-0	180	90	10.91	348.5	1298.7	77.45	144.3

## Calculation of Deflection of Profile

Variables	f = Deflection (mm) F = Load (N) L = Free length (M) I = Geom. moment of inertia (cm <sup>4</sup> )
-----------	--------------------------------------------------------------------------------------------------------------

Example 1

$$f = \frac{F \times L^3}{2.1 \times I}$$

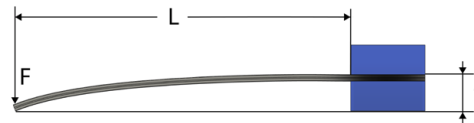

Example 2

$$f = \frac{F \times L^3}{33.6 \times I}$$

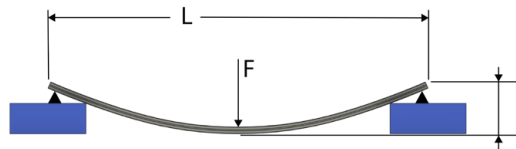

Example 3

$$f = \frac{F \times L^3}{134.4 \times I}$$

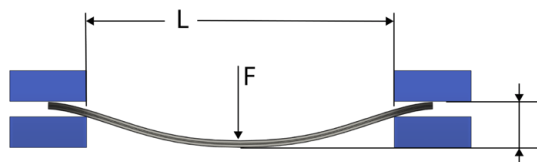





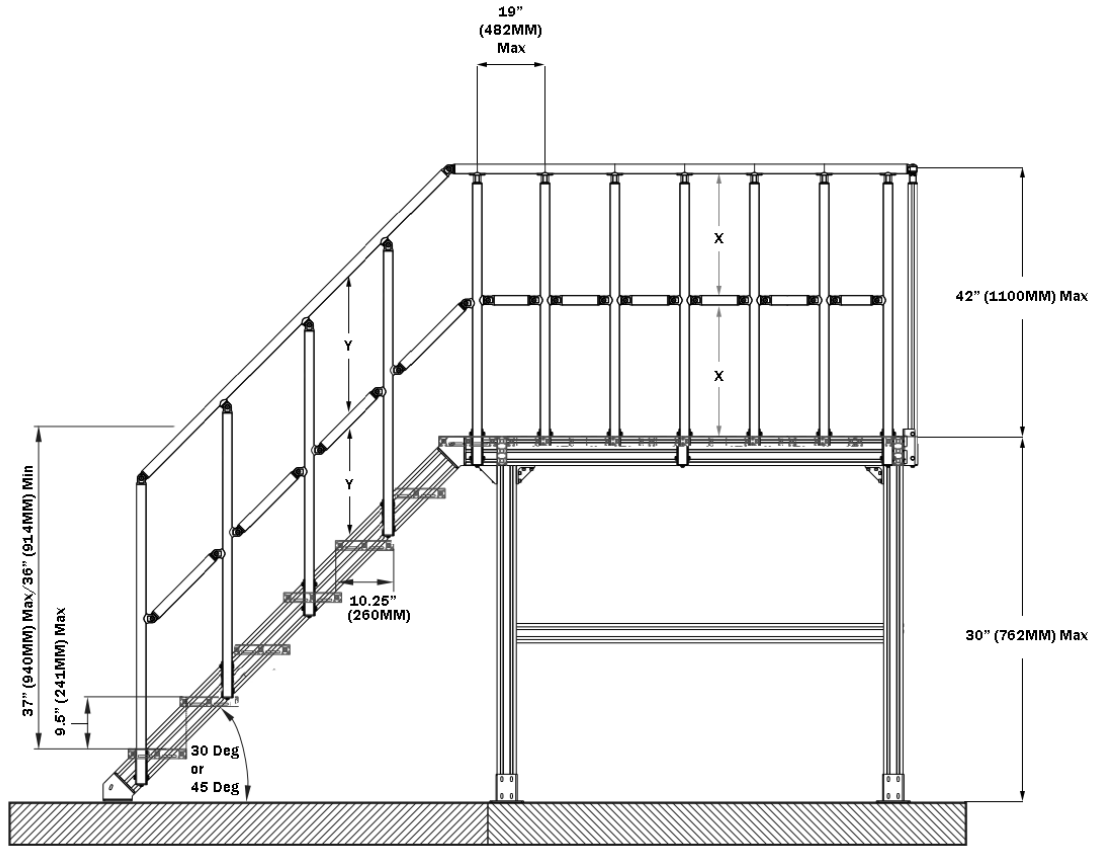

The following are general safety requirements for stairs/mezzanines. Please also check local codes for your area.

- Stairways with four or more risers or rising more than 30 inches (76 CM) in height— whichever is less— must be installed along each unprotected side or edge.
- Top edges of stair rail systems used as handrails must not be more than 37 inches (94 CM) high nor less than 36 inches (91.5 CM) from the upper surface of the stair rail system to the surface of the tread.
- Unprotected sides and edges of stairway landings must have standard 42 inch (1.1 M) guardrail systems.
- Intermediate vertical members, such as balusters used as guardrails, must not be more than 19 inches (48 CM) apart. If their intermediate structural members, when used, must be installed so that no openings are more than 19 inches (48 CM) wide.
- Handrails and top rails of the stair rail system must be able to withstand without failure, at least 200 pounds (890 N) of weight applied within 2 inches (5 CM) of the top edge in any downward or outward direction, at any point along the top edge.
- Fixed stairs shall be positioned within the range of 30 degrees

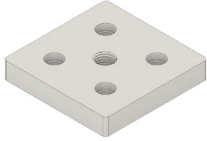
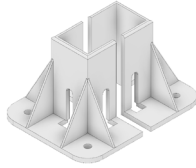
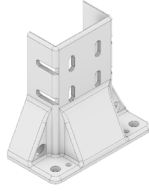
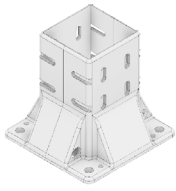

- to 50 degrees to the horizontal with uniform riser height and tread width throughout each run and be capable of a minimum loading of 100 pounds per square foot (445 N) and a minimum concentrated load of 300 pounds (1,334 N) at the center of any tread span.
- Riser height shall be between treads of 6 to 9.5 inches (15.24 to 24.13 CM), stair width a minimum of 22 inches (55.88 CM) between vertical barriers, tread depth a minimum of 10 inches (25.4 CM), and tread nosing shall be straight leading edges.
- Stair landings shall be at least 20 inches (50.8 CM) in depth. Where doors or gates open on a stairway, a landing platform
- Fixed stairs shall be positioned within the range of 30 degrees to 50 degrees to the horizontal with uniform riser height and tread width shall be provided. Door swing shall not reduce effective standing area on the landing to less than 18 inches (45.72 CM) in depth.
- Restricted areas. When physical features require stairs steeper than those provided for, stairs at angles of 50° to 75° from the horizontal may be used if they:
  - Have open treads at least 4 inches (10.16 CM) in depth and 18 inches (45.72 CM) in width with a uniformly spaced vertical rise between treads of 6 to 9.5 inches (15.24 to 24.13 CM)
  - Maintenance. Fixed stairways shall be maintained in safe condition and shall not be obstructed.
  - Are capable of a single concentrated load of 200 pounds (890 N) at the tread centers.

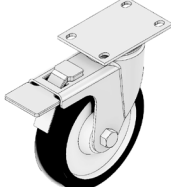

				
<b>30-M16D100-1</b> Leveling Foot 100MM Pad - M16 Thread W/ Jam Nut	<b>32-9090M16-1</b> Mounting Plate 90MM X 90MM W/ M16 Hole & Hardware	<b>33-4590-1</b> 4 Sided Foot 45MM X 90MM W/ Hardware	<b>33-4590S-1</b> 3 Sided Foot 45MM X 90MM W/ Hardware	<b>33-9090-1</b> 4 Sided Foot 90MM X 90MM W/ Hardware
				
<b>34-270-1</b> Support Angle Bracket 270MM - W/ Hardware	<b>31-RPD5-5</b> Rigid Plate Caster 5" - W/ Hardware	<b>31-SPD5-5</b> Swivel Plate Caster 5" - W/ Hardware	<b>31-SPD5-7</b> Swivel Plate Caster 5" - W/ Lock & Hardware	<b>31-SPLFD100PU-0</b> Swivel Plate Caster 5" - W/ Lift Foot



**10-40R1-0**  
Round Profile  
40MM  
1 Slot















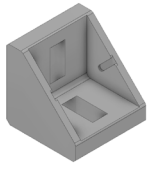
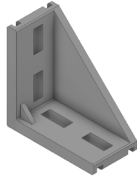
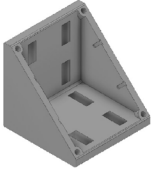

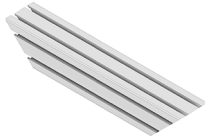

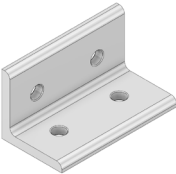
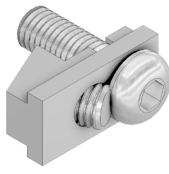

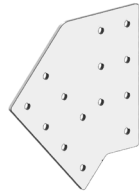

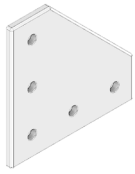
**10-40R2-0**  
Round Profile  
40MM  
2 Slot

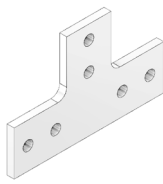

**30-M16D100-1**  
Leveling Foot  
100MM Pad - M16  
Thread



**10-940-1**  
Step Profile

					
<b>40-110-1</b> Aluminum Gusset 45MM X 45MM W/ Hardware	<b>40-120-1</b> Aluminum Gusset 45MM X 90MM W/ Hardware	<b>40-130-1</b> Aluminum Gusset 90MM X 90MM W/ Hardware	<b>40-34590-1</b> Strengthening Element 45MM X 90MM Aluminum 360MM Long W/ Hardware	<b>40-39090-1</b> Strengthening Element 90MM X 90MM Aluminum 460MM Long W/ Hardware	<b>40-530-1</b> Angle Bracket 90MM X 90MM W/ Hardware
					
<b>40-540-1</b> Angle Bracket 45MM X 90MM W/ Hardware	<b>41-002-0</b> Speedlock Hidden Profile Fastener M5 Socket	<b>41-120-1</b> Flat Connecting Plate 90MM X 90MM W/ Hardware	<b>41-130-1</b> Flat Connecting Plate 45MM X 180MM W/ Hardware	<b>41-135-1</b> 45 Deg Joining Plate 45MM X 180MM Typically Used for Stairs W/ Hardware	<b>41-140-1</b> Flat Connecting Plate 90MM X 180MM W/ Hardware
					
<b>41-150-1</b> Flat Connecting Plate 135MM X 135MM W/ Hardware	<b>41-160-0</b> Flat Connecting Plate 180MM X 180MM W/ Hardware	<b>41-170-0</b> Flat Connecting Plate 135MM X 135MM W/ Hardware	<b>41-174-1</b> Flat Connecting Plate 135MM X 135MM W/ Hardware	<b>43-000-1</b> Flat Connecting Plate For Connecting Stair Tread to Stair Frame W/ Hardware	<b>43-100-0</b> Stair Rail Connector 40MM Round Rail to 45MM X 180MM Profile
					
<b>43-2FF-0</b> Stair Rail Connector Flat to Flat Pivot for 40MM Round Rail	<b>43-2FR-0</b> Stair Rail Connector Flat to Round Pivot for 40MM Round Rail	<b>43-300-0</b> Stair Rail Connector 90 Deg for 40MM Round Rail	<b>43-430-0</b> Stair Rail Connector 30 Deg for 45MM x 180MM Stair Stringer	<b>43-445-0</b> Stair Rail Connector 45 Deg for 45MM x 180MM Stair Stringer	<b>43-460-0</b> Stair Rail Connector 60 Deg for 45MM x 180MM Stair Stringer



**43-2FR-0**  
Stair Rail Connector  
Flat to Round Pivot  
for 40MM Round Rail



**10-40R1-0**  
Round Profile  
40MM  
1 Slot



**43-2FF-0**  
Stair Rail Connector  
Flat to Flat Pivot for  
40MM Round Rail



**10-940-1**  
Step Profile



**10-40R2-0**  
Round Profile  
40MM  
2 Slot

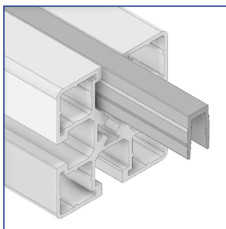
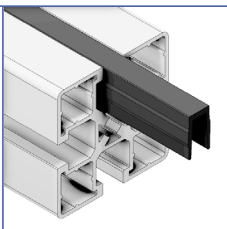
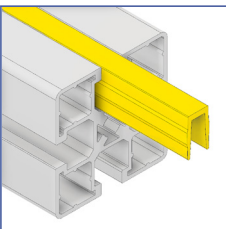
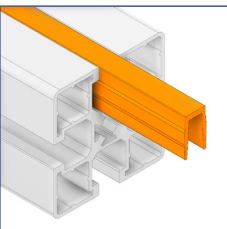
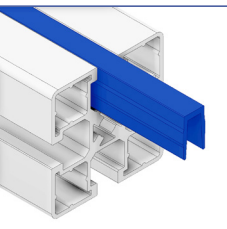
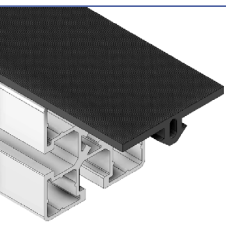

**43-100-0**  
Stair Rail Connector  
40MM Round Rail to  
45MM X 180MM  
Profile

					
<b>61-010-0</b> PVC Cover Profile Gray 2M	<b>61-010-1</b> PVC Cover Profile Black 2M	<b>61-010-2</b> PVC Cover Profile Yellow 2M	<b>61-010-3</b> PVC Cover Profile Orange 2M	<b>61-010-4</b> PVC Cover Profile Blue 2M	<b>61-070-0</b> PVC Cover Profile Flat Rubber W/ Ridges 1M





## EASY SOLUTIONS





**10-940-1**  
Step Profile



**10-45180-0**  
Square Profile  
45MM X 180MM



**43-000-1**  
Flat Connecting Plate  
For Connecting Stair  
Tread to Stair Frame



**43-430-0**  
Stair Rail Connector  
30 Deg for 45MM x  
180MM Stair Stringer

### ONLINE PARTS CATALOG

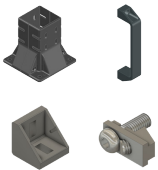

#### Looking for Other Parts?

We have many other parts on our online catalog.

- Profiles
- Brackets & Connectors
- Door Hardware
- Panel Inserts
- Cable Management
- Linear Systems
- Fasteners

Go to  
[The-Modular-Solution.com](http://The-Modular-Solution.com)  
for more info.

## M8 X 1.25 Fasteners

Button Head Cap Screw - Zinc Plated



Length	Part #
12MM	M8X12BHCS-0
16MM	M8X16BHCS-0
18MM	M8X18BHCS-0
20MM	M8X20BHCS-0
22MM	M8X22BHCS-0
25MM	M8X25BHCS-0
30MM	M8X30BHCS-0
35MM	M8X35BHCS-0
40MM	M8X40BHCS-0
45MM	M8X45BHCS-0
50MM	M8X50BHCS-0

Low Head Socket Head Cap Screw - Zinc Plated



Length	Part #
12MM	M8X12LHSCS-0
16MM	M8X16LHSCS-0
18MM	M8X18LHSCS-0
20MM	M8X20LHSCS-0
22MM	M8X22LHSCS-0
25MM	M8X25LHSCS-0
30MM	M8X30LHSCS-0
35MM	M8X35LHSCS-0
40MM	M8X40LHSCS-0
45MM	M8X45LHSCS-0
50MM	M8X50LHSCS-0

Flat Head Cap Screw - Zinc Plated



Length	Part #
12MM	M8X12FHCS-0
16MM	M8X16FHCS-0
18MM	M8X18FHCS-0
20MM	M8X20FHCS-0
22MM	M8X22FHCS-0
25MM	M8X25FHCS-0
30MM	M8X30FHCS-0
35MM	M8X35FHCS-0
40MM	M8X40FHCS-0
45MM	M8X45FHCS-0
50MM	M8X50FHCS-0

Square Nut W/ Position Fixing Spring - Zinc Plated



Part #
M8S-PF

Square Nut W/ Position Fixing Spring - Stainless Steel

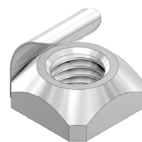

Part #
M8S-PF-3

Rectangular Nut W/ Position Fixing Spring - Zinc Plated



Part #
M8L-PF

Square Nut - Zinc Plated

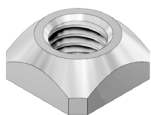

Part #
M8S-0

Square Nut - Stainless Steel

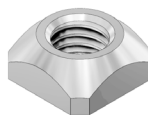

Part #
M8S-3

Rectangular Nut - Zinc Plated



Part #
M8L-0

## Hex Nut - Zinc Plated



Thread	Part #
M4	M4H-0
M5	M5H-0
M6	M6H-0
M8	M8H-0

## Cerated Flange Hex Nut - Zinc Plated

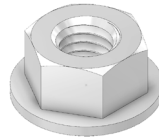

Thread	Part #
M4	M4F-0
M5	M5F-0
M6	M6F-0
M8	M8F-0

## Fender Washer - Zinc Plated



Thread	Part #
M6	M6FW-0
M8	M8FW-0

## Standard Washers - Zinc Plated

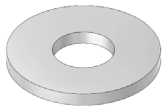

Thread	Part #
M4	M4SMW-0
M5	M5SMW-0
M6	M6SMW-0
M8	M8SMW-0
M10	M10SMW-0
M16	M16SMW-0

## Square Washers - Zinc Plated

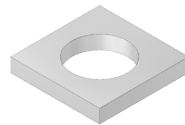

Thread	Part #
M5	M5SW-0
M6	M6SW-0
M8	M8SW-0

## Lock Washers - Zinc Plated



Thread	Part #
M4	M4LKW-0
M5	M5LKW-0
M6	M6LKW-0
M8	M8LKW-0
M10	M10LKW-0

## T- Handle Allen Wrench



**23-004-0**  
T-Handle Allen Wrench  
4MM



**23-005-0**  
T-Handle Allen Wrench  
5MM

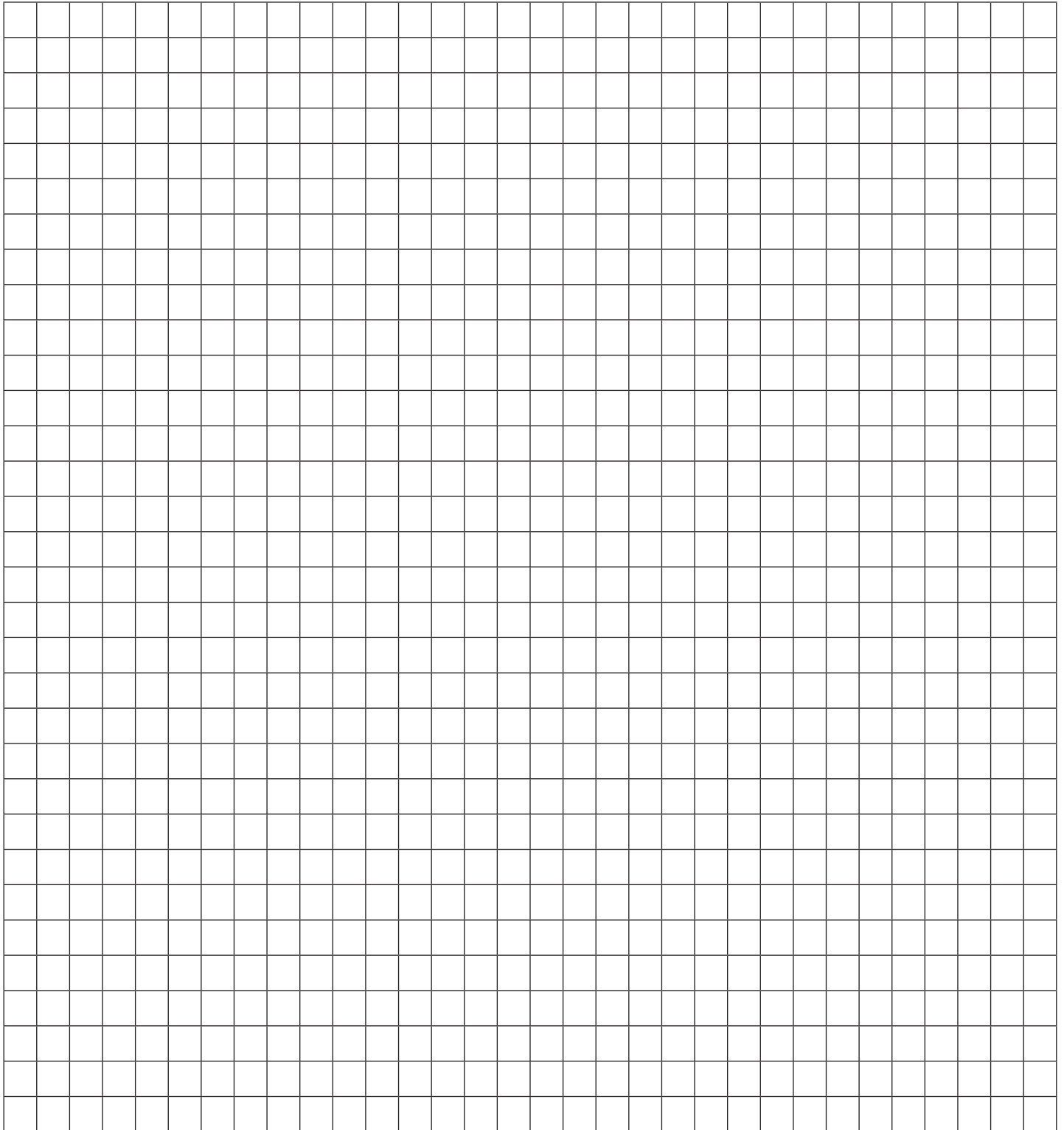

## MODULAR SOLUTIONS

Modular Solutions is a manufacturer of custom engineered structures and automation solutions

We pride ourselves on offering innovative products, selection tools and services that simplify the process of ordering and assembly thus offering increased value and time savings.



Profile

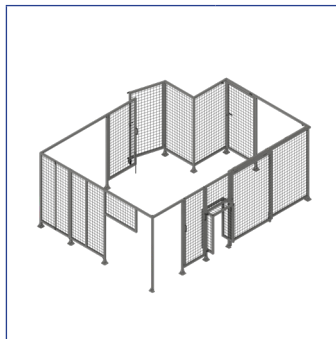

Guarding



Conveyors

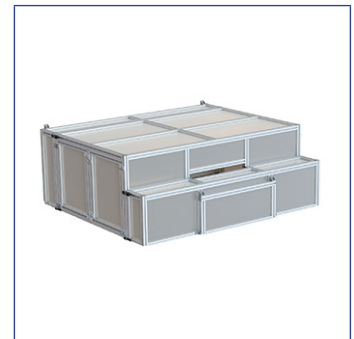

Enclosures



Carts



Work Benches

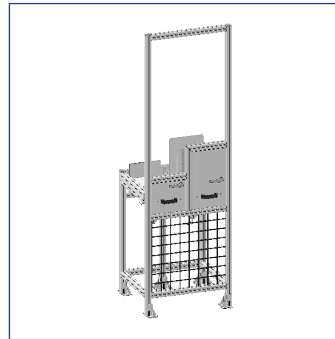

Drawer Systems



Flow Racks

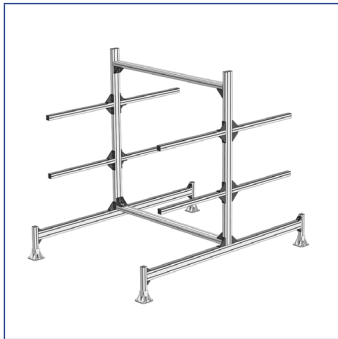

Stands & Fixtures

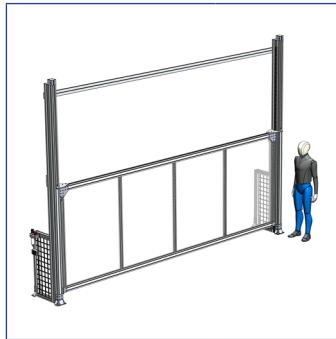

Doors



Linear Systems

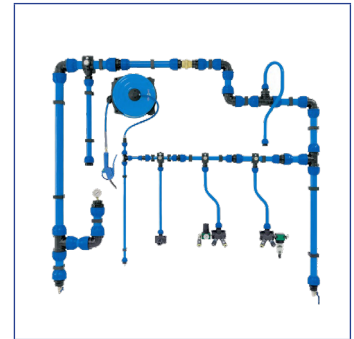

Modular Pipe Systems